

# LIGHTWAY 5 – OUTDOOR / OPAL

## LONG ROTATION ARM

The Lightway 5 outdoor opal is developed for homogenous lighting in harsh environments. This IP65 element benefits from a wide variety of outputs. The diffuser offers powerful lighting and excellent light transmission with high diffusion.

The fixture is available with an aluminum anti glare shield that gives control over the light for increased visual comfort.

- Superior optical transmission with no visible LED hotspots
- Wide, even levels of illumination
- High angle distribution to illuminate vertical & horizontal surfaces
- Great color mixing capability
- Integrates with any architecture.



### Luminaire

**Application:** Ambient  
**Body Material:** Extruded aluminium

### Installation

**Ambient Temperature:** -10 to 40°C

### Optics

**Surface Diffuser:** Acrylic Opal Diffusing Lens

### Electrical equipment

**Mains Voltage:** 220-240 VAC 50/60 Hz  
**Control Gear Efficacy:** > 85%

### Polar Curve

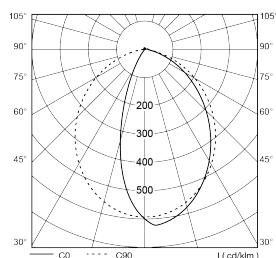

LOR: 37.6%

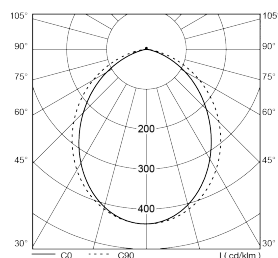

LOR: 55.5%

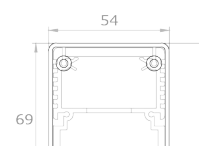
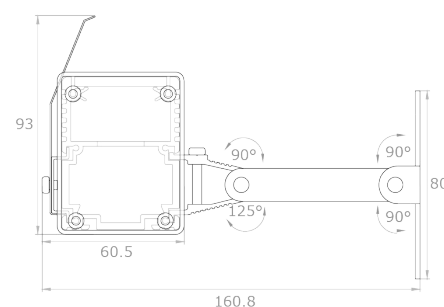
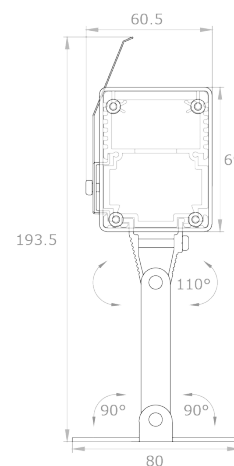

We reserve the right to make technical changes without prior notice



# LIGHTWAY 5 – OUTDOOR / OPAL LONG ROTATION ARM

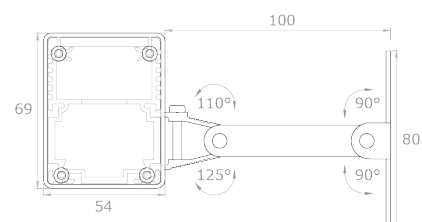
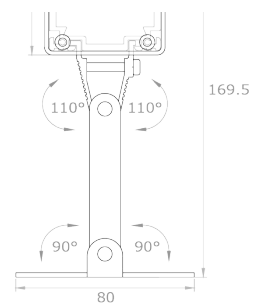

*We reserve the right to make technical changes without prior notice*

# LIGHTWAY 5 – OUTDOOR / OPAL

## LONG ROTATION ARM

### Code Index:

<u>L 5</u>	<u>O</u>	<u>S 2</u>	<u>—</u>	<u>A O</u>	<u>X X</u>	<u>— — — —</u>	<u>—</u>	<u>6 5</u>	<u>— —</u>	<u>— — —</u>	<u>— —</u>	
Family	Environment	Mounting	Glare Control	Accessory	Optic	Beam Angle	CRI/CCT & Power	Control	IP	Body Finish	Length	Wiring
				S			927L1	C		BS	30	BI
				X			927L2	D		WS	60	BB
							927L3	E		GS	90	BM
							927L4				120	BE
							927L5					SI
							930L1					SB
							930L2					SM
							930L3					SE
							930L4					
							930L5					
							940L1					
							940L2					
							940L3					
							940L4					
							940L5					

Family	Environment	Mounting	Glare Control Accessory	Optic	Beam Angle
L5 Lightway 5	O Outdoor	S2 Long Rotation Arm	S With Anti-Glare Shield X Without Anti-Glare Shield	AO Opal Diffuser	XX N/A

CRI/CCT & Power	Control	IP	Body Finish
<p>LED Load initial Lumen</p> <p>2700°K</p> <p>927L1: 10 W/m 1200 lm/m</p> <p>927L2: 15 W/m 1650 lm/m</p> <p>927L3: 22 W/m 2150 lm/m</p> <p>927L4: 30 W/m 3250 lm/m</p> <p>927L5: 42 W/m 4300 lm/m</p>	<p>C Built-in driver, non-dimmable</p> <p>D Built-in driver, DALI</p> <p>E Built-in driver, 1-10V</p>	65 IP65	<p>BS Black Smooth</p> <p>WS White Smooth</p> <p>GS Gray Smooth</p>
<p>3000°K</p> <p>930L1: 10 W/m 1350 lm/m</p> <p>930L2: 15 W/m 1900 lm/m</p> <p>930L3: 22 W/m 2550 lm/m</p> <p>930L4: 30 W/m 3800 lm/m</p> <p>930L5: 42 W/m 5100 lm/m</p>			
<p>4000°K</p> <p>940L1: 10 W/m 1450 lm/m</p> <p>940L2: 15 W/m 2050 lm/m</p> <p>940L3: 22 W/m 2700 lm/m</p> <p>940L4: 30 W/m 4050 lm/m</p> <p>940L5: 42 W/m 5400 lm/m</p>			

Length	Wiring
30 30 cm	BI Bottom feeding, Individual
60 60 cm	BB Bottom feeding, Beginning
90 90 cm	BM Bottom feeding, Middle
120 120 cm	BE Bottom feeding, End
	SI Side feeding, Individual
	SB Side feeding, Beginning
	SM Side feeding, Middle
	SE Side feeding, End

We reserve the right to make technical changes without prior notice