

LIGHTWAY 5 – OUTDOOR / WASHER BEAM

SHORT ROTATION ARM

The Lightway 5 Outdoor beam is developed for maximum performance in harsh environmental conditions. Made from extruded aluminum, this IP65 element benefits from a wide variety of outputs. The Beam compatible with a wide array of beam angles, generating a powerful overall lighting effect.

The fixture is available with an aluminum anti glare shield that gives control over the light for increased visual comfort.

- Diverse options of beam angles: very narrow, narrow, medium, wide and elliptic
- Delivers High levels of light
- Integrates with any architecture.



Luminaire

Application: Washer
Body Material: Extruded aluminium

Installation

Ambient Temperature: -10 to 40°C

Optics

Optic Type: UV stabilized TIR Lens

Electrical equipment

Mains Voltage: 220-240 VAC 50/60 Hz
Control Gear Efficacy: > 85%

Polar Curve

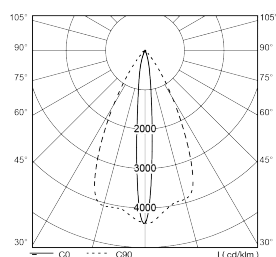

Elliptical beam 10° x 54° /
LOR: 62.6%

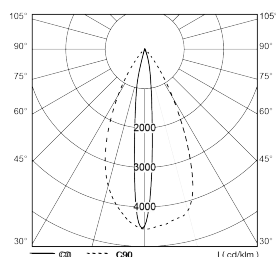

Elliptical beam 10° x 54° /
LOR: 58.1%

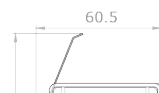
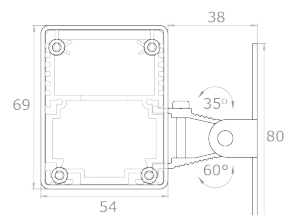
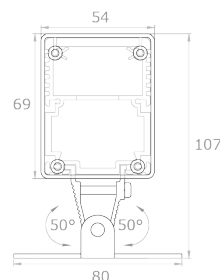

We reserve the right to make technical changes without prior notice

LIGHTWAY 5 – OUTDOOR / WASHER BEAM SHORT ROTATION ARM

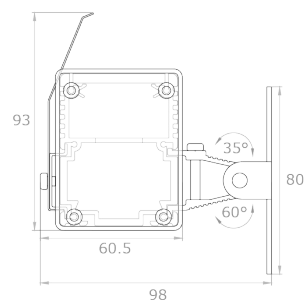
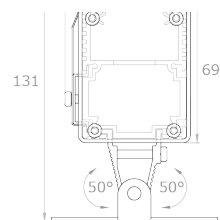

We reserve the right to make technical changes without prior notice

LIGHTWAY 5 – OUTDOOR / WASHER BEAM

SHORT ROTATION ARM

Code Index:

<u>L 5</u>	<u>O</u>	<u>S 1</u>	<u>W T</u>	<u>E 1</u>	<u>6 5</u>						
Family	Environment	Mounting	Glare Control Accessory	Optic	Beam Angle	CRI/CCT & Power	Control	IP	Body Finish	Length	Wiring
			S			92701	C		BS	30	BI
			X			92702	D		WS	60	BB
						92703	E		GS	90	BM
						93001				120	BE
						93002					SI
						93003					SB
						94001					SM
						94002					SE
						94003					

Family	Environment	Mounting	Glare Control Accessory	Optic	Beam Angle
L5 Lightway 5	O Outdoor	S1 Short Rotation Arm	S With Anti-Glare Shield X Without Anti-Glare Shield	WT Beam	E1 Elliptical beam 10° x 54°

CRI/CCT & Power	Control	IP	Body Finish																														
<table border="1"> <thead> <tr> <th></th> <th>LED Load</th> <th>initial Lumen</th> </tr> </thead> <tbody> <tr> <td>2700°K</td> <td>92701: 20 W/m</td> <td>2260 lm/m</td> </tr> <tr> <td></td> <td>92702: 30 W/m</td> <td>3090 lm/m</td> </tr> <tr> <td></td> <td>92703: 42 W/m</td> <td>4110 lm/m</td> </tr> <tr> <td>3000°K</td> <td>93001: 20 W/m</td> <td>2360 lm/m</td> </tr> <tr> <td></td> <td>93002: 30 W/m</td> <td>3230 lm/m</td> </tr> <tr> <td></td> <td>93003: 42 W/m</td> <td>4290 lm/m</td> </tr> <tr> <td>4000°K</td> <td>94001: 20 W/m</td> <td>2550 lm/m</td> </tr> <tr> <td></td> <td>94002: 30 W/m</td> <td>3500 lm/m</td> </tr> <tr> <td></td> <td>94003: 42 W/m</td> <td>4640 lm/m</td> </tr> </tbody> </table>		LED Load	initial Lumen	2700°K	92701: 20 W/m	2260 lm/m		92702: 30 W/m	3090 lm/m		92703: 42 W/m	4110 lm/m	3000°K	93001: 20 W/m	2360 lm/m		93002: 30 W/m	3230 lm/m		93003: 42 W/m	4290 lm/m	4000°K	94001: 20 W/m	2550 lm/m		94002: 30 W/m	3500 lm/m		94003: 42 W/m	4640 lm/m	C Built-in driver, non-dimmable D Built-in driver, DALI E Built-in driver, 1-10V	65 IP65	BS Black Smooth WS White Smooth GS Gray Smooth
	LED Load	initial Lumen																															
2700°K	92701: 20 W/m	2260 lm/m																															
	92702: 30 W/m	3090 lm/m																															
	92703: 42 W/m	4110 lm/m																															
3000°K	93001: 20 W/m	2360 lm/m																															
	93002: 30 W/m	3230 lm/m																															
	93003: 42 W/m	4290 lm/m																															
4000°K	94001: 20 W/m	2550 lm/m																															
	94002: 30 W/m	3500 lm/m																															
	94003: 42 W/m	4640 lm/m																															

Length	Wiring
30 30 cm	BI Bottom feeding, Individual
60 60 cm	BB Bottom feeding, Beginning
90 90 cm	BM Bottom feeding, Middle
120 120 cm	BE Bottom feeding, End
	SI Side feeding, Individual
	SB Side feeding, Beginning
	SM Side feeding, Middle
	SE Side feeding, End